

Grothendieck-Teichmüller Theory Moduli Spaces and Multizeta Values

Arizona Winter School
March 12-16, 2005

Part I: Grothendieck-Teichmüller theory

§I.1. What is Grothendieck-Teichmüller theory?

Let $G_{\mathbb{Q}}$ be the absolute Galois group of \mathbb{Q} , i.e. the (topological) group of automorphisms of the separable closure $\overline{\mathbb{Q}}$ of \mathbb{Q} , which act trivially on \mathbb{Q} .

Central Theme of Grothendieck-Teichmüller Theory: Study $G_{\mathbb{Q}}$ via its *geometric* actions, i.e. its actions on fundamental groups of geometric objects (varieties, schemes, stacks...) And above all, according to Grothendieck, one should concentrate attention on the *moduli spaces of curves*, which in some sense contain all possible information about algebraic curves and varieties over $\overline{\mathbb{Q}}$.

So, following the program Grothendieck sketched out in his famous text *Esquisse d'un Programme*, one should begin by examining the action of $G_{\mathbb{Q}}$ on fundamental groups of moduli spaces of curves, obtaining in this way information about the elements of $G_{\mathbb{Q}}$ which is very different from what can be obtained by studying number fields directly. vskip .2cm In this first lecture we will begin this study, but only on genus zero moduli spaces to start with; the reason for this is that a remarkable piece of work by Drinfel'd (1991) provided a key way to approach Grothendieck's program in the genus zero case.

The very first question one might ask about an element $\sigma \in G_{\mathbb{Q}}$ is: how can you write it down? How can you express it, say what it is? The fact is that $G_{\mathbb{Q}}$ is a *profinite group*. Recall that the *profinite completion* of a group is given by the inverse limit of the system of all its finite quotients:

$$\widehat{G} = \varprojlim G/N$$

where N runs through the normal subgroups of finite index of G . A profinite group is the inverse limit of its finite quotients, so that to give an element of $G_{\mathbb{Q}}$ explicitly, we need to know its image in each finite quotient. But we do not even know the finite quotients of $G_{\mathbb{Q}}$! The only element which can really be written down in an explicit sense is complex conjugation.

The purpose of the theory developed by Grothendieck in §2 of *Esquisse d'un Programme* is:

1) to identify each element $\sigma \in G_{\mathbb{Q}}$ with a pair

$$(\chi(\sigma), f_{\sigma}) \in \widehat{\mathbb{Z}}^* \times \widehat{F}'_2.$$

Here $\chi : G_{\mathbb{Q}} \rightarrow \widehat{\mathbb{Z}}^*$ is just the cyclotomic character giving the action of $G_{\mathbb{Q}}$ on roots of unity; we have the exact sequence

$$1 \rightarrow G_{\mathbb{Q}^{\text{ab}}} \rightarrow G_{\mathbb{Q}} \rightarrow \widehat{\mathbb{Z}}^* \rightarrow 1,$$

so for any $\sigma \in G_{\mathbb{Q}}$, $\chi(\sigma)$ is a very well-understood quantity. As for $f_{\sigma} \in \widehat{F}'_2$, which is the derived subgroup of the profinite completion of the free group \widehat{F}_2 on two generators, well, \widehat{F}_2 is a much simpler group than $G_{\mathbb{Q}}$. It is also profinite, so we still cannot always write down an element completely. However, because we understand this group well, there are various ways to characterize an element or a certain subset of elements of \widehat{F}_2 just by giving its properties. This is why it is very interesting to be able to write $\sigma \in G_{\mathbb{Q}}$ as a pair $(\chi(\sigma), f_{\sigma})$ both of whose components belong to much simpler groups than $G_{\mathbb{Q}}$.

Grothendieck indicated how to do this in *Esquisse d'un Programme*, but the work was completed by Drinfel'd and Ihara. We will see how to do it in §I.3 below.

The second part of Grothendieck's program is still the hard part:

2) Find necessary and sufficient conditions on $f \in \widehat{F}'_2$ for it to come from a $\sigma \in G_{\mathbb{Q}}$.

Studying the action of $G_{\mathbb{Q}}$ on fundamental groups of moduli spaces of curves has yielded several beautiful necessary conditions. But sufficiency is still a real mystery.

§I.2. Galois groups and fundamental groups

Before discussing the action of $G_{\mathbb{Q}}$ on the fundamental groups of moduli spaces, let us look at the base case $\mathbb{P}^1 - \{0, 1, \infty\}$, and how it relates to *dessins d'enfants*. This situation leads to the general fundamental groups of moduli spaces in a very natural way.

Geometric Galois actions always stem from the following basic situation.

Namely, if X is any algebraic variety (scheme, stack...) defined over \mathbb{Q} , let $\pi_1(X)$ denote its topological fundamental group and $\widehat{\pi}_1(X)$ its algebraic fundamental group, which is the profinite completion of the topological one. Then there is a **canonical outer action**

$$G_{\mathbb{Q}} \rightarrow \text{Out}(\widehat{\pi}_1(X)). \quad (1)$$

Moreover this outer action *preserves conjugacy classes of inertia groups*.

Let us explain where the outer Galois action in (1) comes from. The left-hand column of the following diagram shows a finite cover Y of X , sitting under the universal cover \widetilde{X} of X , with Galois group the topological π_1 , the middle column shows the function field situation over \mathbb{C} , where the top field is the compositum of all the function fields of the finite covers Y and therefore the Galois group is the profinite completion of the topological π_1 , and the right-hand column uses the Lefschetz theorem to descend from \mathbb{C} to the algebraically closed subfield $\overline{\mathbb{Q}}$ without changing the Galois group, so that the natural inclusion of the field $\mathbb{Q}(X)$ into $\overline{\mathbb{Q}}(X)$, with Galois group $G_{\mathbb{Q}}$, gives a canonical outer action of $G_{\mathbb{Q}}$ on $\widehat{\pi}_1(X)$.

$$\begin{array}{ccc}
 \begin{array}{c} \widetilde{X} \\ | \\ \pi_1(X) \left(\begin{array}{c} Y \\ | \\ X \end{array} \right) \end{array} &
 \begin{array}{c} \widetilde{\mathbb{C}(X)} \\ | \\ \widehat{\pi}_1(X) \left(\begin{array}{c} \mathbb{C}(Y) \\ | \\ \mathbb{C}(X) \end{array} \right) \end{array} &
 \begin{array}{c} \widetilde{\overline{\mathbb{Q}}(X)} \\ | \\ \widehat{\pi}_1(X) \left(\begin{array}{c} \overline{\mathbb{Q}}(Y) \\ | \\ \overline{\mathbb{Q}}(X) \end{array} \right) \\ G_{\mathbb{Q}} \left(\begin{array}{c} | \\ \mathbb{Q}(X) \end{array} \right) \end{array}
 \end{array}$$

§I.3. The case $\mathbb{P}^1 - \{0, 1, \infty\}$

Let $X = \mathbb{P}^1 - \{0, 1, \infty\}$, so that the topological π_1 is F_2 , the free group on two generators, which we write $\langle x, y, z \mid xyz = 1 \rangle$, identifying x , y and z with loops around 0, 1 and ∞ respectively.

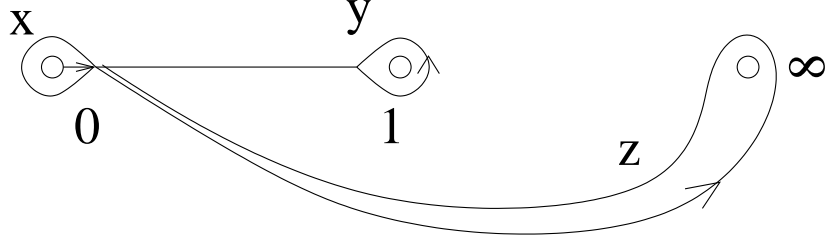

We saw in §I.2 that we have a canonical homomorphism

$$G_{\mathbb{Q}} \rightarrow \text{Out}(\widehat{\pi}_1(\mathbb{P}^1 - \{0, 1, \infty\}))$$

i.e.

$$G_{\mathbb{Q}} \rightarrow \text{Out}(\widehat{F}_2).$$

The inertia groups are $\langle x \rangle$, $\langle y \rangle$ and $\langle z \rangle$, so we know that for each $\sigma \in G_{\mathbb{Q}}$, there exist $\alpha, \beta, \lambda \in \widehat{\mathbb{Z}}^*$ and $f, g \in \widehat{F}_2$ such that

$$\begin{cases} \sigma(x) = x^\alpha \\ \sigma(y) = g^{-1}y^\beta g \\ \sigma(z) = h^{-1}z^\lambda h \end{cases}$$

lifts the canonical outer action of σ on \widehat{F}_2 .

In $\widehat{F}_2^{\text{ab}} = \widehat{\mathbb{Z}} \times \widehat{\mathbb{Z}}$, this means that $x^\alpha y^\beta z^\lambda = 1$, which is only possible if $\alpha = \beta = \lambda$. Suppose $g \equiv x^\delta y^\epsilon$ in $\widehat{F}_2^{\text{ab}}$, and set $f = y^{-\epsilon} g x^\delta$. Then

$$\begin{cases} \sigma(x) = x^\alpha \\ \sigma(y) = f^{-1}y^\beta f \end{cases}$$

is the unique lifting of the outer action of σ such that $f \in \widehat{F}'_2$.

We have obtained a map

$$G_{\mathbb{Q}} \rightarrow \widehat{\mathbb{Z}}^* \times \widehat{F}'_2.$$

This map is NOT a group homomorphism. It corresponds to associating to $\sigma \in G_{\mathbb{Q}}$ the automorphism $F_{\sigma} \in \text{Aut}(\widehat{F}_2)$ associated to the pair $(\lambda_{\sigma}, f_{\sigma})$ such that

$$\begin{cases} x \mapsto x^{\lambda_{\sigma}} \\ y \mapsto f_{\sigma}^{-1} y^{\lambda_{\sigma}} f_{\sigma}. \end{cases}$$

If $\sigma, \tau \in G_{\mathbb{Q}}$, the product $\sigma \cdot \tau$ corresponds to applying first the automorphism τ , then σ , so we get

$$\begin{aligned} x &\xrightarrow{\tau} x^{\lambda_{\tau}} \xrightarrow{\sigma} x^{\lambda_{\sigma}\lambda_{\tau}} \\ y &\xrightarrow{\tau} f_{\tau}^{-1} y^{\lambda_{\tau}} f_{\tau} \xrightarrow{\sigma} F_{\sigma}(f_{\tau})^{-1} f_{\sigma}^{-1} y^{\lambda_{\sigma}\lambda_{\tau}} f_{\sigma} F_{\sigma}(f_{\tau}). \end{aligned}$$

In other words, the pair corresponding to $\sigma \cdot \tau$ is

$$(\lambda_{\sigma}\lambda_{\tau}, f_{\sigma}F_{\sigma}(f_{\tau})).$$

§I.4. Dessins d'enfants

4.1. Definitions. A *dessin d'enfant* is a triple $X_0 \subset X_1 \subset X_2$ where X_0 is a finite set of points on a compact topological surface X_2 of genus g , and X_1 is a subset of X_2 such that $X_2 \setminus X_1$ is a disjoint union of open cells (simply connected regions) of X_2 . The set X_1 consists of edges connecting the vertices.

The dessin is only defined up to isotopy on the surface, and we also require it to be *bicolorable*, i.e. we want to be able to color the vertices in two colors, black and white, in such a way that all neighbors of every vertex of a given color are of the opposite color.

Which of the following are dessins?

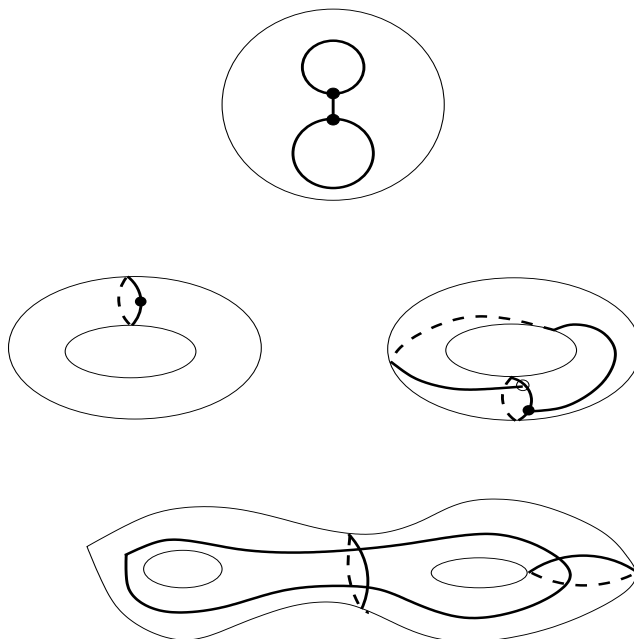

By classical covering theory, the following sets are all in bijection with each other.

- {dessins d'enfant}
- {finite covers of the Riemann surface \mathbb{P}^1 unramified outside $\{0, 1, \infty\}$ }, up to isomorphism (these are known as *Belyi covers*)
- {finite unramified topological covers of the thrice-punctured sphere}, up to equivalence
- {conjugacy classes of subgroups of finite index of \widehat{F}_2 }

The second and third bijections just use the following basic facts about Riemann surfaces and topological covers: the finite unramified topological covers of a topological space X are classified by the finite index subgroups of $\pi_1(X)$, and if we have a finite topological cover $\beta : Y \rightarrow X$ and we equip X with an analytic structure (here, the topological thrice-punctured sphere is given the structure of the Riemann sphere $\mathbb{P}^1 - \{0, 1, \infty\}$), then the structure on X lifts to a unique analytic structure on Y .

The first bijection is the pretty one: it is given by associating to a Belyi cover

$$\beta : X \rightarrow \mathbb{P}^1$$

the preimage $\beta^{-1}([0, 1])$ of the segment $[0, 1]$ in \mathbb{P}^1 (automatically bicolorable).

The degree of the cover is equal to the number of edges $\bullet \text{---} \circ$ of the dessin.

The points over 0 correspond to black vertices of the dessin, the points over 1 to white vertices.

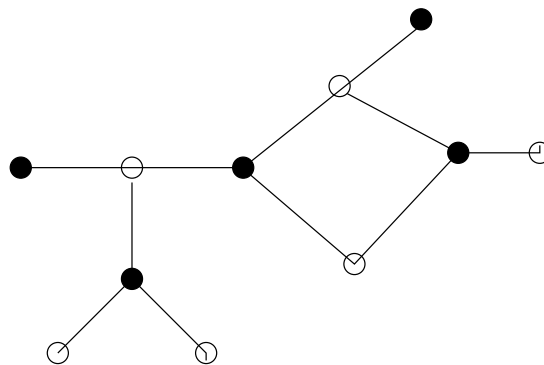

Example. Genus=0, Degree = 11
 5 preimages of 0, 6 preimages of 1
 2 preimages of ∞

You can visualize the cover topologically by triangulating the dessin (adding a vertex marked \star in each face, and adding edges joining it up to the black and white vertices).

This paves the dessin surface with diamonds

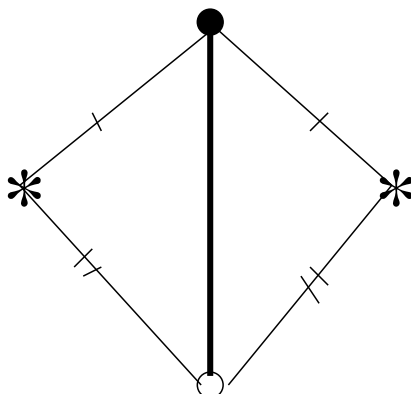

each of which contains exactly one edge of the actual dessin.

The cover identifies the marked pairs of edges, so the quotient is a sphere with three branch points.

The group F_2 acts on the set of edges of the dessin D as follows:

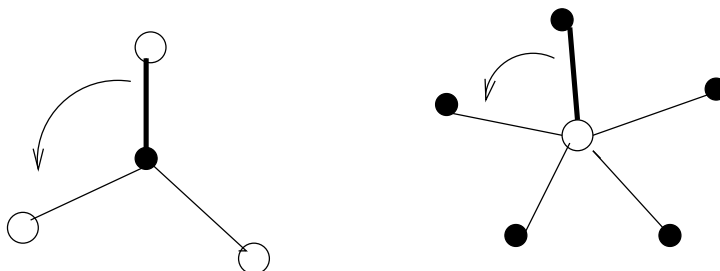

Pick any edge e of the dessin and let $N = \text{Stab}(e)$; then N is a finite-index subgroup of \widehat{F}_2 . The stabilizers of the different flags from a conjugacy class of finite-index subgroups in \widehat{F}_2 , and this conjugacy class corresponds to a finite cover of \mathbb{P}^1 , namely exactly the Belyi cover $\beta : X \rightarrow \mathbb{P}^1$.

The degree of the cover is the number of edges e , and the set of edges is in bijection with the coset space \widehat{F}_2/N ; furthermore the action of \widehat{F}_2 on the edges is exactly the action on \widehat{F}_2/N by right multiplication. Obviously, \widehat{F}_2 acts via a finite quotient, called the *monodromy group* of the dessin or the cover.

The whole dessin can be reconstructed just by knowing N (up to conjugacy):

- Edges are in bijection with \widehat{F}_2/N ;
- orbits of \widehat{F}_2/N under x are sets of stars centered around black vertices (edges attached to same black vertex);
- similarly, orbits of \widehat{F}_2/N under y are sets of stars centered around white vertices.

4.2. Galois action on dessins

The action of $G_{\mathbb{Q}}$ on \widehat{F}_2 sends N to N^σ , so it sends the dessin D to a dessin D^σ . The field

$$K_D = \text{fixed field of } \{\sigma \in G_{\mathbb{Q}} \mid N^\sigma = N, \text{ i.e. } D^\sigma = D\}$$

is called *the moduli field of D* .

Thus, each dessin is naturally defined over a number field, and the set of dessins is naturally equipped with a Galois action.

Now, what we would like is to give a list of **combinatorial Galois invariants** of dessins, the dream being to give a list sufficient to determine Galois orbits of dessins. To start with, there are some obvious Galois invariants:

- number of edges, faces, black, white vertices
- ramification indices, i.e. valencies of black and white vertices;
- monodromy group...

All these are *geometric*, i.e. they have to do with the ramification information of the associated Belyi cover.

Example: Consider the following two dessins.

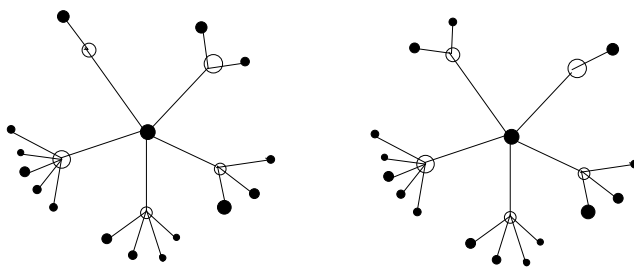

Every one of the preceding, geometric invariants of these two dessins is equal. There are 24 dessins having the same valency lists. However, it is actually possible to EXPLICITLY COMPUTE the associated number fields and see that these two dessins are NOT Galois conjugates.

The valencies at the black vertices are $(5, 1, \dots, 1)$ and at the white vertices $(2, 3, 4, 5, 6)$. If you take dessins with the same black valencies and various 5-tuples of white valencies, you sometimes get a Galois orbit of 24 and sometimes two Galois orbits of 12, as here.

Y. Kochetkov computed many examples and noticed that the Galois orbit appeared to split exactly when the white valencies are (a, b, c, d, e) such that

$$abcde(a + b + c + d + e) \text{ is a square.}$$

This conjecture was generalized and proved by Leonardo Zapponi (1997), who actually came up with a NEW GALOIS INVARIANT – arithmetic, not geometric – for a large family of dessins.

§I.5. Diffeomorphisms of topological surfaces

We now move to the more general case of the Galois action on fundamental groups of moduli spaces. In this section we give a topological description of these fundamental groups.

Let S be a topological surface of genus g , with n distinct ordered marked points (x_1, \dots, x_n) .

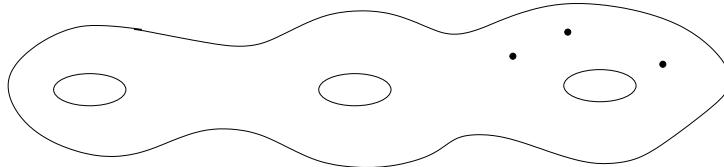

Let $M_{g,n}$ denote the *moduli space of Riemann surfaces of type (g, n)* . The points of $M_{g,n}$ are isomorphism classes of these Riemann surfaces; it can also be considered as the space of analytic structures on S up to isomorphism.

In the case of *genus zero*, we are working with Riemann spheres marked with n distinct ordered points (x_1, \dots, x_n) , up to isomorphism. The isomorphisms are $\text{PSL}_2(\mathbb{C})$, which is triply transitive; this means that we can always find a unique representative

$$(0, 1, \infty, y_1, \dots, y_{n-3})$$

for each isomorphism class (=point of $M_{0,n}$), or in other words, a unique element $\gamma \in \mathrm{PSL}_2(\mathbb{C})$ such that $\gamma(x_1) = 0$, $\gamma(x_2) = 1$, $\gamma(x_3) = \infty$.

Thus, the space $M_{0,n}$ is isomorphic to

$$(\mathbb{P}^1 - \{0, 1, \infty\})^{n-3} - \Delta,$$

where Δ denotes the union of the lines $x_i = x_j$.

PATHS on moduli space are thus continuous parametrized deformations of the analytic structure of the starting point x (a given Riemann surface).

In particular, LOOPS (up to homotopy) are exactly (orientation preserving) diffeomorphisms of x (up to those homotopic to the identity).

This means that if we define the *mapping class group* to be

$$\Gamma_{g,n} = \mathrm{Diff}^+(S)/\mathrm{Diff}^0(S)$$

and fix a base point $x \in M_{g,n}$, we have an isomorphism

$$\Gamma_{g,n} \simeq \pi_1(M_{g,n}, x) \simeq \mathrm{Diff}^+(S)/\mathrm{Diff}^0(S).$$

Caveat: A topological manifold is the quotient of a simply connected space (the universal cover) by a discrete group acting freely properly discontinuously. Here, we are working with a generalization of this situation. Topologically, the moduli spaces are not manifolds but *orbifolds*, obtained by quotienting a topological space (called Teichmüller space) by a discrete group, $\Gamma_{g,n}$, acting properly discontinuously but not freely; certain points of Teichmüller space are fixed by finite subgroups of $\Gamma_{g,n}$. Thus, $\Gamma_{g,n}$ is called the *orbifold fundamental group* of $M_{g,n}$. As the $M_{g,n}$ are defined over \mathbb{Q} , we have a canonical outer Galois action on the profinite orbifold fundamental groups exactly as explained in §I.2.

Each group $\Gamma_{g,n}$ is generated by a certain set of diffeomorphisms called **Dehn twists** along simple closed loops on the topological surface Σ of type (g, n) .

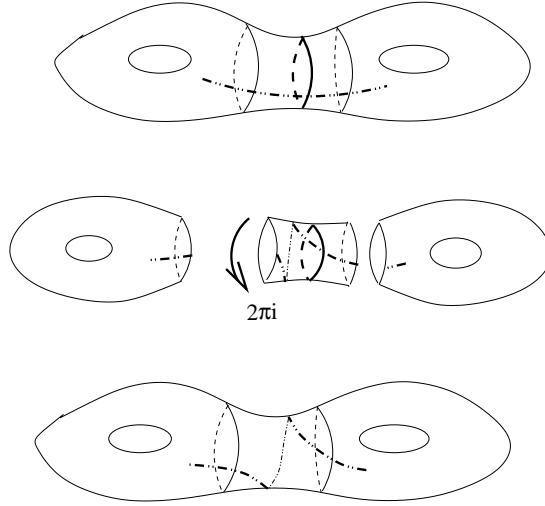

Dehn twists correspond to certain particularly well-understood loops in the fundamental group, corresponding to classical inertia generators (more on this later).

The identification of the fundamental group of moduli space with the group of diffeomorphisms of a topological surface gives us an approach to our **GOAL**: using the way in which the absolute Galois group $G_{\mathbb{Q}}$ acts on the fundamental groups of moduli spaces to understand as much as possible about its elements.

§I.6. The Grothendieck-Teichmüller group

Recall from §I.3 that we have an injective set map

$$G_{\mathbb{Q}} \rightarrow \widehat{\mathbb{Z}}^* \times \widehat{F}'_2$$

$$\sigma \mapsto (\chi(\sigma), f).$$

We can now view this in the framework moduli spaces.

As we saw in §I.5, the moduli space $M_{0,4}$ is isomorphic to $\mathbb{P}^1 - \{0, 1, \infty\}$, since it is the moduli space of Riemann spheres with 4 ordered marked points, and each isomorphism class of such spheres has a unique representative with marked points

$$(x_1, x_2, x_3, x_4) = (0, 1, \infty, x).$$

There are three basic simple closed loops on the sphere: one surrounding x_1 and x_2 , one surrounding x_2 and x_3 and one surrounding x_1 and x_3 .

The fundamental group $\pi_1(M_{0,4})$ is just F_2 , the free group on two generators. The three Dehn twists along the three loops above are the generators x, y, z with $xyz = 1$.

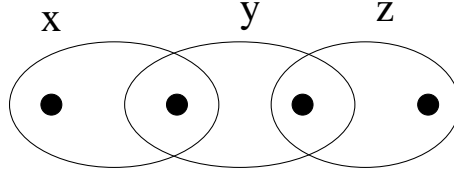

Notation: For any group homomorphism

$$\begin{aligned} \widehat{F}_2 &\rightarrow G \\ x, y &\mapsto a, b \end{aligned}$$

we write $f(a, b)$ for the image of $f \in \widehat{F}_2$.

For example:

- under $\text{id} : \widehat{F}_2 \rightarrow \widehat{F}_2$, we have $f = f(x, y)$;
- under the map $\widehat{F}_2 \rightarrow \widehat{F}_2$ exchanging the generators x and y , we have

$$f = f(x, y) \mapsto f(y, x).$$

Definition. The *Grothendieck-Teichmüller group* \widehat{GT} is the group of pairs $(\lambda, f) \in \widehat{\mathbb{Z}}^* \times \widehat{F}'_2$ such that $x \mapsto x^\lambda$ and $y \mapsto f^{-1}y^\lambda f$ induces an automorphism of \widehat{F}_2 , and such that

$$(I) \quad f(x, y)f(y, x) = 1,$$

$$(II) \quad f(x, y)x^m f(z, x)z^m f(y, z)y^m = 1 \text{ where } xyz = 1 \text{ and } m = (\lambda - 1)/2,$$

(III) (5-cycle relation) $f(x_{34}, x_{45})f(x_{51}, x_{12})f(x_{23}, x_{34})f(x_{45}, x_{51})f(x_{12}, x_{23}) = 1$ in $\widehat{\Gamma}_{0,5}$, where x_{ij} is the Dehn twist along a loop (on a sphere with 5 numbered marked points) surrounding points i and j .

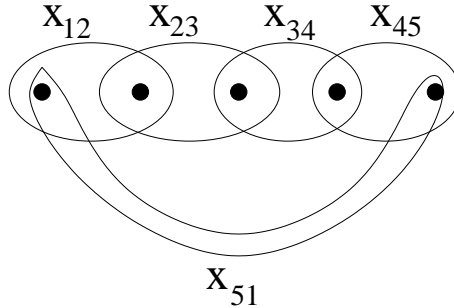

Theorem. (Ihara) *There is an injection $G_{\mathbb{Q}} \hookrightarrow \widehat{GT}$.*

There are now several different ways to understand this theorem which Drinfel'd indicated in the article [D] where he first defined \widehat{GT} , and Ihara proved completely in [I]. Let me outline three different proofs (in order of simplicity, not chronological).

- For $n \geq 5$, the permutation group S_n acting on the n marked points of the sphere gives an automorphism of the moduli space $M_{0,n}$; in fact, $S_n = \text{Aut}(M_{0,n})$. Thus S_n can be naturally identified with a subgroup of $\text{Out}(\widehat{\Gamma}_{0,n})$. The main theorem of [HS] states that for all $n \geq 5$, \widehat{GT} can be identified with the subgroup of $\text{Out}(\widehat{\Gamma}_{0,n})$ of outer automorphisms preserving inertia (i.e. conjugacy classes of cyclic groups generated by Dehn twists) and commuting with S_n . Now, we saw in §I.2 that $G_{\mathbb{Q}}$ injects naturally into $\text{Out}(\widehat{\Gamma}_{0,n})$, and preserves inertia; furthermore, since the permutations of S_n give automorphisms of $M_{0,n}$ defined over \mathbb{Q} , the image of $G_{\mathbb{Q}}$ in $\text{Out}(\widehat{\Gamma}_{0,n})$ commutes with S_n . Thus $G_{\mathbb{Q}} \subset \widehat{GT}$. The advantage of this proof is that it uses almost nothing about $G_{\mathbb{Q}}$.

- We can approach this more arithmetically by using the fact that not only does $G_{\mathbb{Q}}$ act on (homotopy classes of) *loops* on a variety X based at a \mathbb{Q} -point, but also on (homotopy classes of) *paths* on X from one \mathbb{Q} -point to another. Ihara explained that the geometric meaning of the element $f_{\sigma}(x, y)$ is that if p denotes the path from 0 to 1 (taking tangential base points), then $\sigma(p) = pf(x, y)$. Now, we could also consider the path r from 0 to $1/2$, and write $\sigma(r) = rg(x, y)$. Let $\Theta(z)$ be the automorphism of \mathbb{P}^1 defined by $\Theta(z) = 1 - z$; then $p = \Theta(r)^{-1}r$, so we have

$$\begin{aligned} \sigma(p) &= pf(x, y) = \sigma(\Theta(r))^{-1}\sigma(r) = \Theta(g(x, y)^{-1}r^{-1})rg(x, y) \\ &= g(\Theta(x), \Theta(y))^{-1}\Theta(r)^{-1}rg(x, y) = g(\Theta(x), \Theta(y))^{-1}pg(x, y) \\ &= pg(p^{-1}\Theta(x)p, p^{-1}\Theta(y)p)^{-1}g(x, y) \\ &= pg(y, x)^{-1}g(x, y). \end{aligned}$$

Thus $f(x, y) = g(y, x)^{-1}g(x, y)$, making relation (I) obvious. Relations (II) and (III) can be obtained in the same way, by dividing the path p into “pieces”.

- Another way to see the real, geometric meaning of relations (I) and (II) is that a pair (λ, f) which gives an automorphism of $\widehat{F}_2 = \pi_1(M_{0,4})$ extends to the group $\pi_1(M_{0,[4]})$, where $M_{0,[4]} = M_{0,4}/S_4$ is the moduli space classifying spheres with four *unordered* marked points. The group $\pi_1(M_{0,[4]})$ is the three-strand braid group B_3 modulo its center; it is generated by σ_1, σ_2 subject to the relations $(\sigma_1\sigma_2\sigma_1)^2 = 1$ and $(\sigma_1\sigma_2)^3 = 1$. Since the moduli space $M_{0,[4]}$ is also defined over \mathbb{Q} , there is a $G_{\mathbb{Q}}$ -action on \widehat{B}_3/Z extending the action on the subgroup $\widehat{F}_2 = \pi_1(M_{0,4})$ (identified with $\langle \sigma_1^2, \sigma_2^2 \rangle$). Relations (I) and (II) are equivalent to requiring that the extended action respects the two defining relations of

\widehat{B}_3/Z . This establishes that pairs $(\chi(\sigma), f_\sigma)$ from $G_{\mathbb{Q}}$ satisfy relations (I) and (II). Now, there is a \mathbb{Q} -morphism between moduli spaces $M_{0,5} \rightarrow M_{0,4}$ obtained by erasing the fifth marked point, and this gives a homomorphism $\widehat{\Gamma}_{0,5} \rightarrow \widehat{\Gamma}_{0,4} = \widehat{F}_2$ which must be respected by the $G_{\mathbb{Q}}$ -actions on $\widehat{\Gamma}_{0,5}$ and $\widehat{\Gamma}_{0,4}$. Ihara showed that (III) was a necessary and sufficient for the action on $\widehat{\Gamma}_{0,4}$ to extend to an action on $\widehat{\Gamma}_{0,5}$, respecting the above homomorphism.

The injectivity of the homomorphism $G_{\mathbb{Q}} \hookrightarrow \widehat{GT}$ is a consequence of Belyi's theorem, which states that an algebraic curve X over \mathbb{C} has a model over $\overline{\mathbb{Q}}$ if and only if it can be realized as a cover $\beta : X \rightarrow \mathbb{P}^1$ unramified outside the three points 0, 1 and ∞ . (??)

§I.7. The two-level principle

The “unordered” fundamental group $\Gamma_{0,[n]}$ is generated by Dehn twists $\sigma_1, \dots, \sigma_{n-1}$ with relations $\sigma_i \sigma_{i+1} \sigma_i = \sigma_{i+1} \sigma_i \sigma_{i+1}$, $\sigma_1 \cdots \sigma_{n-1} \cdot \sigma_{n-1} \cdots \sigma_1 = 1$ and $(\sigma_1 \cdots \sigma_{n-1})^n = 1$. Quotienting this group modulo the σ_i^2 gives a surjection onto S_n , and the group $\Gamma_{0,n} \subset \Gamma_{0,[n]}$ is the kernel of this surjection.

We saw in §I.6 that the defining relations (I), (II) and (III) are exactly what is needed in order to ensure that we have homomorphisms

$$\widehat{GT} \rightarrow \text{Out}(\widehat{\Gamma}_{0,[4]}), \quad \widehat{GT} \rightarrow \text{Out}(\widehat{\Gamma}_{0,[5]})$$

which extend the homomorphisms of $G_{\mathbb{Q}}$. But we have more.

Theorem. (D, I-M) *For all $n \geq 4$, there is a homomorphism $\widehat{GT} \rightarrow \text{Out}(\widehat{\Gamma}_{0,[n]})$ extending the action of $G_{\mathbb{Q}}$ on these fundamental groups. It is given explicitly by the formula*

$$\sigma_i \mapsto f(\sigma_i^2, y_i) \sigma_i^\lambda f(\sigma_i^2, y_i), \quad 1 \leq i \leq n-1$$

where $y_i = \sigma_{i-1} \cdots \sigma_1 \cdot \sigma_1 \cdots \sigma_{i-1}$.

What this means is that in fact, it is enough to ensure that \widehat{GT} acts as automorphisms of $\widehat{\Gamma}_{0,[4]}$ and $\widehat{\Gamma}_{0,[5]}$ in order to automatically get an action on all of the $\widehat{\Gamma}_{0,[n]}$.

This phenomenon, called the “two-level principle”, was predicted by Grothendieck in the following words:

The a priori interest of a complete knowledge of the two first levels of the tower (i.e. the cases where the modular dimension $3g - 3 + n \leq 2$) is to be found in the principle that *the entire tower can be reconstituted from these two first levels...*

Interpreted in terms of group actions, this says that the action on all mapping class groups of higher dimension ($= 3g - 3 + n$, dimension of the moduli space) should be

completely determined by the action on those of dimension 1 and 2, namely $\widehat{\Gamma}_{0,4}$, $\widehat{\Gamma}_{0,5}$, $\widehat{\Gamma}_{1,1}$, $\widehat{\Gamma}_{1,2}$. This is exactly what we saw in the case of genus zero.

§I.8. Higher genus

Grothendieck did not suggest restricting attention to genus zero moduli spaces, yet the group \widehat{GT} discovered by Grothendieck seems to arise naturally in the genus zero situation. It has not been possible to prove as yet that \widehat{GT} also acts on the higher genus mapping class groups $\widehat{\Gamma}_{g,n}$.

However, the situation is really not too bad, because it turns out that adding just one relation to the three defining relations of \widehat{GT} , we obtain a new group (a priori a subgroup of \widehat{GT} , although nobody seems to be able to prove that it is really a *proper* subgroup), which does act on all the mapping class groups $\widehat{\Gamma}_{g,n}$ with all desirable good properties.

By looking in $\widehat{F}_2^{\text{ab}}$, we see that the relation $f(x, y) = g(y, x)^{-1}g(x, y)$ implies that for $F = (\lambda, f) \in \widehat{GT}$, there exists $\rho_2(F) \in \mathbb{Z}$ such that $g(x, y) \equiv (xy)^{\rho_2(F)}$ in $\widehat{F}_2^{\text{ab}}$.

The new relation (IV) which we add to the definition of \widehat{GT} is given by:

$$f(e_1, a_1)a_3^{-8\rho_2} f(a_2^2, a_3^2)(a_3a_2a_3)^{2m} f(e_2, e_1)e_2^{2m} \cdot \\ f(e_3, e_2)a_2^{-2m}(a_1a_2a_1)^{2m} f(a_1^2, a_2^2)a_1^{8\rho_2} f(a_3, e_3) = 1,$$

where a_1, a_2, a_3, e_1, e_2 and e_3 are Dehn twists along the simple closed loops on a topological surface of type (1, 2) shown in the following figure:

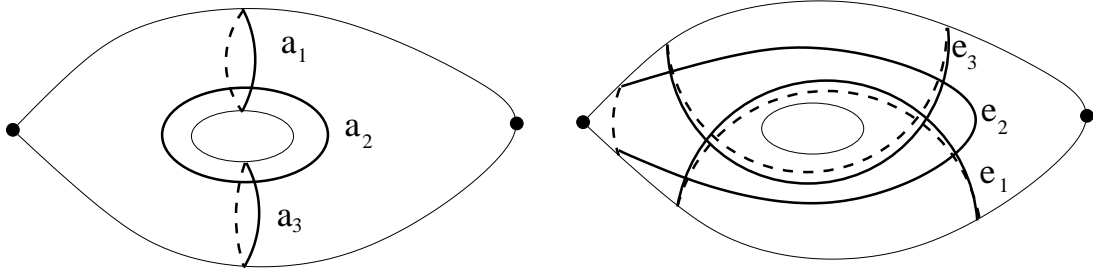

Let Λ denote the subgroup of \widehat{GT} defined by relations (I)-(IV). Then relation (IV) ensures that there is a homomorphism $\Lambda \rightarrow \text{Out}(\widehat{\Gamma}_{1,2})$ extending the canonical homomorphism $G_{\mathbb{Q}} \rightarrow \text{Out}(\widehat{\Gamma}_{1,2})$.

What's more, Grothendieck's two-level principle turns out to be right! Namely, we also obtain:

Theorem. *There is a homomorphism*

$$\Lambda \rightarrow \text{Out}(\widehat{\Gamma}_{g,n})$$

extending the canonical homomorphism $G_{\mathbb{Q}} \rightarrow \text{Out}(\widehat{\Gamma}_{g,n})$ homomorphism for all (g, n) .

The nice observation is that, since the moduli space $M_{1,1}$ of elliptic curves has fundamental group $\widehat{\Gamma}_{1,1} = \widehat{B}_3/Z$, we can see relation (I) as coming from $\Gamma_{0,4}$, (II) from $\Gamma_{1,1}$, (III) from $\Gamma_{0,5}$ and (IV) from $\Gamma_{1,2}$. Exactly the first two levels of the tower of moduli spaces.

§I.9. The game of Lego-Teichmüller

Grothendieck saw the two-level principle as following from the fact that all topological surfaces can be built up by gluing smaller pieces together along simple closed loops.

Including the holomorphic sphere with three marked points (coming from $M_{0,3}$, i.e. from level 0), we find *twelve fundamental “building blocks”* (6 of genus 0, 6 of genus 1) in a “game of Lego-Teichmüller” (large box), where the points marked on the surfaces considered are replaced by “holes” with boundary, so as to have surfaces with boundary, functioning as building blocks which can be assembled by gentle rubbing as in the ordinary game of Lego dear to our children (or grandchildren...). By assembling them we find an entirely visual way to construct every type of surface (it is essentially these constructions which will be the “base points” for our famous tower), and also to visualise the *elementary “paths”* by operations as concrete as “twists”, or automorphisms of blocks in the game, and to write the *fundamental relations* between composed paths. According to the size (and the price!) of the construction box used, we can even find numerous different descriptions of the Teichmüller tower by generators and relations. The smallest box is reduced to identical blocks, of type (0,3) – these are the Thurston “pants”, and the game of Lego-Teichmüller which I am trying to describe, springing from motivations and reflections of absolute algebraic geometry over the field \mathbb{Q} , is very close to the game of “hyperbolic geodesic surgery” of Thurston, whose existence I learned of last year...

Let us explain the relation between this game of Lego and the two-level principle as it applies to \widehat{GT} or Λ .

Let a **pants decomposition** on S be a maximal set of $3g - 3 + n$ disjoint simple closed loops; they cut S into Thurston pants.

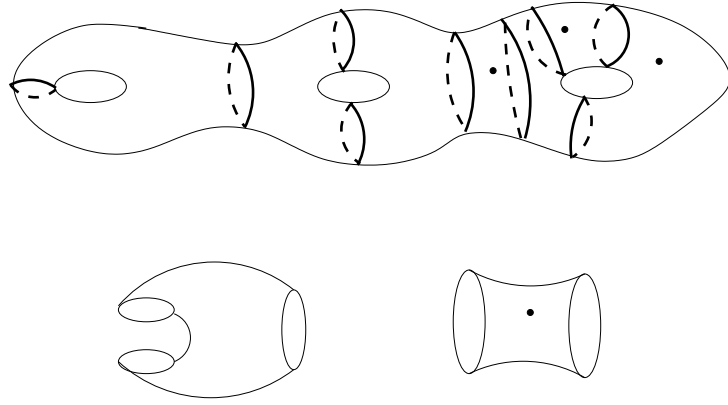

If we erase any one of these loops, then the pants decomposition becomes a decomposition into many pairs of pants and one larger piece, which is always

- either a genus zero piece with four boundary components
- or a genus one piece with one boundary component.

We call this piece the *neighborhood of the loop in the pants decomposition*.

- An A-move on a pants decomposition P is a new pants decomposition obtained from P by erasing one loop and replacing it by another one which intersects the first one in 2 points.

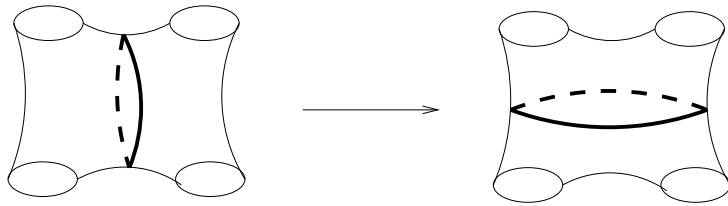

- An S-move on a pants decomposition P is a new pants decomposition obtained from P by erasing one loop and replacing it by another one which intersects the first one in 1 point.

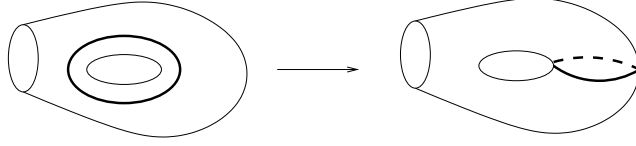

The two-level principle on surfaces means that any topological surface can be equipped with a pants decomposition (i.e. built up by gluing Thurston's pants – small box), or, if we remove certain loops from a pants decomposition, we can see the surface as being built of pieces which can be of any of the types $(0, 3)$, $(0, 4)$ or $(1, 1)$ (large box). The A and S moves on pants decomposition give all possible ways of going between the different ways of from one way of building up the surface.

The fact that the action of Λ on the mapping class groups $\Gamma_{g,n}$ (these should now be the mapping class groups of surfaces with n boundary components rather than punctures, so that we can glue – they are very similar groups and the Λ -action generalizes to them easily) respects the Lego game can be expressed in the Lego Theorem below, which thanks to a certain technical restriction which we will lift in §II.5, we can state in a simple form.

Lego Theorem. *Let S be a topological surface of type (g, n) and let P be a pants decomposition on S . Let $\Lambda_0 \subset \Lambda$ be the subgroup of elements $F = (\lambda, f) \in \Lambda$ such that $\lambda = 1$ and $\rho_2(F) = 0$ (this is the technical restriction). Then the homomorphism $\Lambda_0 \rightarrow \text{Out}(\widehat{\Gamma}_{g,n})$ can be lifted to a homomorphism*

$$\eta_P : \Lambda_0 \rightarrow \text{Aut}_P(\widehat{\Gamma}_{g,n})$$

such that for all $F \in \Lambda_0$:

- (i) $\eta_P(F)(a) = a^\lambda$ if $\alpha \in P$;
- (ii) $\eta_P(F)(b) = f(a, b)^{-1} b^\lambda f(a, b)$ for a unique integer N , if $\alpha \rightarrow \beta$ is an A-move on P ;
- (iii) $\eta_P(F)(c) = f(a^2, c^2)^{-1} c^\lambda f(a^2, c^2)$ if $\alpha \rightarrow \gamma$ is an S-move on P .

Furthermore, if Q is another pants decomposition and $M_1 \dots M_r$ is any sequence of A and S moves taking P to Q , then setting $\epsilon_i = 1$ if M_i is an S-move and 2 if M_i is an A-move, and supposing that M_i takes the loop α_i to the loop β_i , the automorphisms $\eta_P(F)$

and $\eta_Q(F)$ are related by

$$\eta_Q(F) = \text{inn}\left(\prod_{i=1}^r f(a_i^{\epsilon_i}, b_i^{\epsilon_i})\right) \circ \eta_P(F),$$

this expression being independent of the choice of sequence.

The action of Λ_0 (and in fact all of Λ with slightly more complicated expressions, cf. §II.5) thus respects the Lego game of “gluing” or “cutting out subsurfaces” in the following sense. Let $\alpha_1, \dots, \alpha_r$ be a set of disjoint simple closed loops on a topological surface Σ , cutting out a subsurface Σ' . Write $\Gamma(\Sigma')$ and $\Gamma(\Sigma)$ for the associated mapping class groups, so that there is an obvious map

$$\iota : \Gamma(\Sigma') \rightarrow \Gamma(\Sigma),$$

obtained by mapping the Dehn twist along any simple closed loop on Σ' to the Dehn twist along the same loop viewed as sitting on Σ .

To say that the action of Λ_0 on $\widehat{\Gamma}(\Sigma')$ and $\widehat{\Gamma}(\Sigma)$ respects the Lego game means that it respects the homomorphism ι . And indeed, writing P' for the pants decomposition on Σ' obtained by restricting P to Σ' , it follows immediately from the Lego Theorem above that the following diagram commutes:

$$\begin{array}{ccc} \widehat{\Gamma}(\Sigma') & \xrightarrow{\iota} & \widehat{\Gamma}(\Sigma) \\ \eta_{P'}(F) \downarrow & & \downarrow \eta_P(F) \\ \widehat{\Gamma}(\Sigma') & \xrightarrow{\iota} & \widehat{\Gamma}(\Sigma). \end{array}$$

Note in particular that because $G_{\mathbb{Q}} \subset \Lambda$, this theorem holds for the Galois action on the profinite mapping class groups, or at least (for now, because of the technical restriction) for the action of the subgroup $G_{\mathbb{Q}} \cap \Lambda_0$. Thus, the theorem makes a much stronger statement than the standard assertion *the $G_{\mathbb{Q}}$ outer action preserves inertia, i.e. conjugates Dehn twists*. Indeed, for any lifting of $G_{\mathbb{Q}}$ to $\text{Aut}(\widehat{\Gamma}_{g,n})$ corresponding to a given pants decomposition, the Lego Theorem (general version, §II.5) gives a completely explicit formula for the $G_{\mathbb{Q}}$ action on any Dehn twist.

Part II: Geometry of moduli spaces and proof of the Lego Theorem

In this part we introduce the geometry at infinity of the moduli spaces of curves, which is beautiful and important in its own right, but which also leads to the proof of the Lego Theorem. We will end up explaining the proof completely except for one difficult technical result of topological simple connectedness and a technical restriction.

The basic elements of the geometry of the moduli spaces we will study here are:

- the divisor at infinity on the moduli space of curves
- the fundamental group(oid) of the moduli space
- tensor categories (genus zero case)
- complexes of curves (built from simple closed loops)

Then we will turn to the role of curve complexes in Grothendieck-Teichmüller theory and the proof of the Lego theorem.

§II.1. Pinching simple closed loops

The moduli space $M_{g,n}$ of Riemann surfaces of genus g with n ordered marked points can be compactified by adding all *stable curves* (curves with nodes); these can be considered as Riemann surfaces of type (g, n) equipped with disjoint geodesic simple closed loops of length 0.

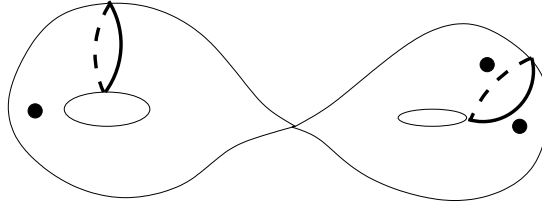

The divisor at infinity of $M_{g,n}$

The “infinite part” or divisor at infinity $\overline{M}_{g,n} - M_{g,n}$ consists of strata of decreasing dimension; each simple closed loop on the topological surface (up to action of the mapping class group) corresponds to a stratum of codimension 1, each pair of disjoint loops to an intersection of two of these, which is a stratum of codimension 2, and so on. A pants decomposition corresponds to a 0-dimensional stratum on the divisor at infinity.

Dehn twists

As we saw, the mapping class group $\Gamma_{g,n}$ can be identified with the orbifold fundamental group of $M_{g,n}$. A *Dehn twist* along a simple closed loop c , in this fundamental group, corresponds to a loop around the corresponding codimension 1 stratum at infinity.

This shows that Dehn twists are *inertia elements* in the fundamental group, which explains the result that $\sigma \in \text{Gal}(\overline{\mathbb{Q}}/\mathbb{Q})$ preserves the conjugacy class of the cyclic group generated by a Dehn twist.

Tangential base points

Equipping a topological surface of type (g,n) with disjoint simple closed loops is equivalent to giving a graph “inside it” with an inner edge corresponding to each loop and a tail to each marked point.

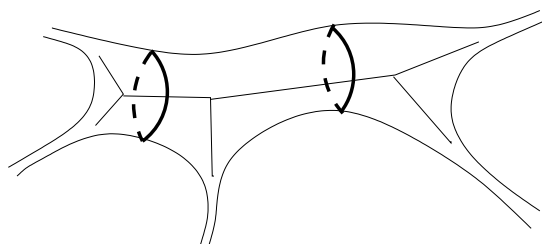

Trivalent trees correspond to pants decompositions.

Consider, in genus zero, the real part of the moduli space $M_{0,n}(\mathbb{R})$ of Riemann spheres with n marked points in \mathbb{R} . Then it is a useful fact that if P denotes a point of maximal degeneration in $\overline{M}_{0,n}$ and V_P denotes a neighborhood of this point, the intersection $V_P \cap M_{0,n}$ falls naturally into 2^{n-3} disjoint simply connected regions corresponding to the different possible cyclic orders of the real marked points. Being simply connected, these regions can be used as base points for a topological fundamental groupoid; they are called *tangential base points of maximal degeneration*. In other words, *the neighborhood in $M_{0,n}$ of a point of maximal degeneration consists of 2^{n-3} simply connected regions corresponding to planar embeddings of the trivalent graph (up to turning them over in the plane).*

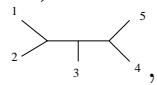
Example: $n = 5$, point of maximal degeneration corresponding to the graph , i.e. to the pants decomposition with a loop around 1 and 2, and a loop around 4 and 5. The possible cyclic orders corresponding to this graph are $(1, 2, 3, 4, 5)$, $(2, 1, 3, 4, 5)$, $(1, 2, 3, 5, 4)$, $(2, 1, 3, 5, 4)$.

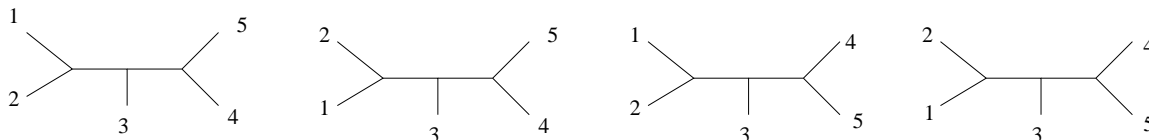

§II.2. The braided tree tensor category and the fundamental groupoid of $M_{0,n}$

A *tensor category* is a category of objects V and morphisms $f : V \rightarrow W$, equipped with a tensor product $V \otimes W$ satisfying suitable functorial conditions with respect to the morphisms, and a set of morphisms called *associativity constraints*

$$a_{U,V,W} : (U \otimes V) \otimes W \rightarrow U \otimes (V \otimes W)$$

satisfying Mac Lane's pentagon relation:

$$\begin{array}{ccc}
 ((U \otimes V) \otimes W) \otimes X & \xrightarrow{a_{U,V,W}} & (U \otimes (V \otimes W)) \otimes X \\
 \downarrow a_{U \otimes V, W, X} & & \downarrow a_{U, V \otimes W, X} \\
 (U \otimes V) \otimes (W \otimes X) & & U \otimes ((V \otimes W) \otimes X) \\
 \downarrow a_{U, V, W \otimes X} & \swarrow a_{V, W, X} & \\
 U \otimes (V \otimes (W \otimes X)) & &
 \end{array}$$

A *braided tensor category* is a tensor category further equipped with morphisms called *commutativity constraints*

$$c_{U,V} : U \otimes V \rightarrow V \otimes U$$

satisfying Mac Lane's two hexagons:

$$\begin{array}{ccccc}
 (U \otimes V) \otimes W & \xrightarrow{a_{U,V,W}} & U \otimes (V \otimes W) & \xrightarrow{c_{U,V \otimes W}} & (V \otimes W) \otimes U \\
 \downarrow c_{U,V} & & & & \downarrow a_{V,W,U} \\
 (V \otimes U) \otimes W & \xrightarrow{a_{V,U,W}} & V \otimes (U \otimes W) & \xrightarrow{c_{U,W}} & V \otimes (W \otimes U)
 \end{array}$$

and

$$\begin{array}{ccccc}
 (U \otimes V) \otimes W & \xrightarrow{c_{U \otimes V, W}} & W \otimes (U \otimes V) & \xrightarrow{a_{W,U,V}^{-1}} & (W \otimes U) \otimes V \\
 \uparrow a_{U,V,W}^{-1} & & & & \uparrow c_{U,W} \\
 U \otimes (V \otimes W) & \xrightarrow{c_{V,W}} & U \otimes (W \otimes V) & \xrightarrow{a_{U,W,V}^{-1}} & (U \otimes W) \otimes V
 \end{array}$$

Objects and morphisms of the braided tree category:

Objects: Trivalent trees with strings hanging from tails

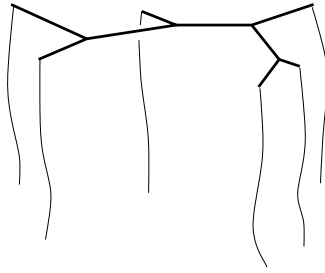

BasicMorphisms: A–moves on the trees

Crossing braids $c_{UV,W}$ on "Y" s

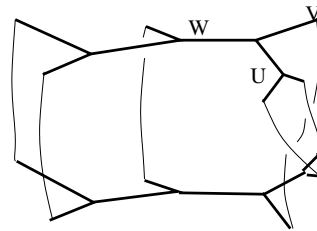
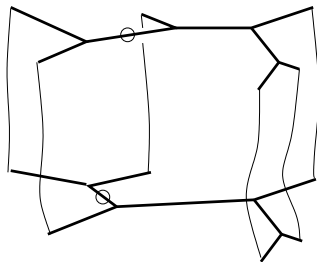

The trivalent trees are numbered as follows: every tail is labeled with a positive integer except for one distinguished tail labeled 0.

Faces (i.e. relations in the category): The only relations are Mac Lane’s two hexagons and pentagon, which we draw here as series of morphisms in the braided tree category:

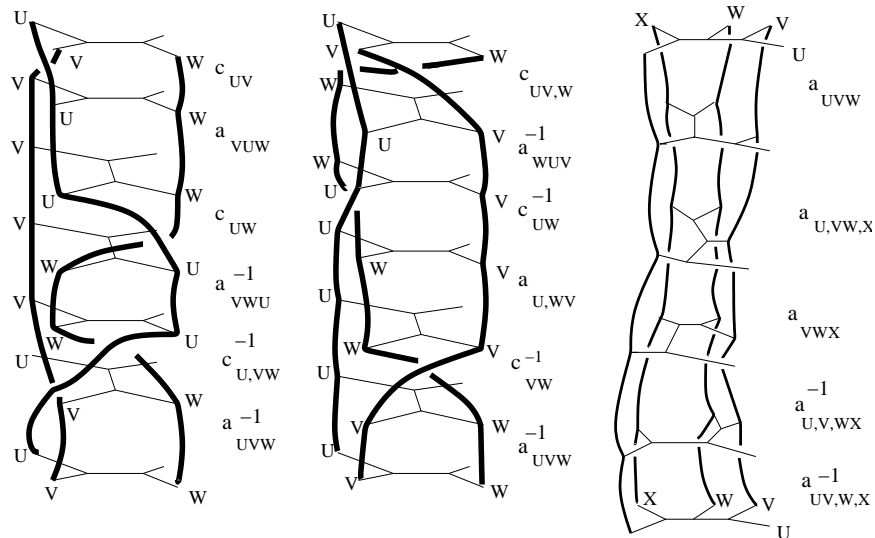

Tensor product: Two trees T and T' give a new tree $T \otimes T'$ by joining the tails numbered 0 and adding a new tail numbered 0.

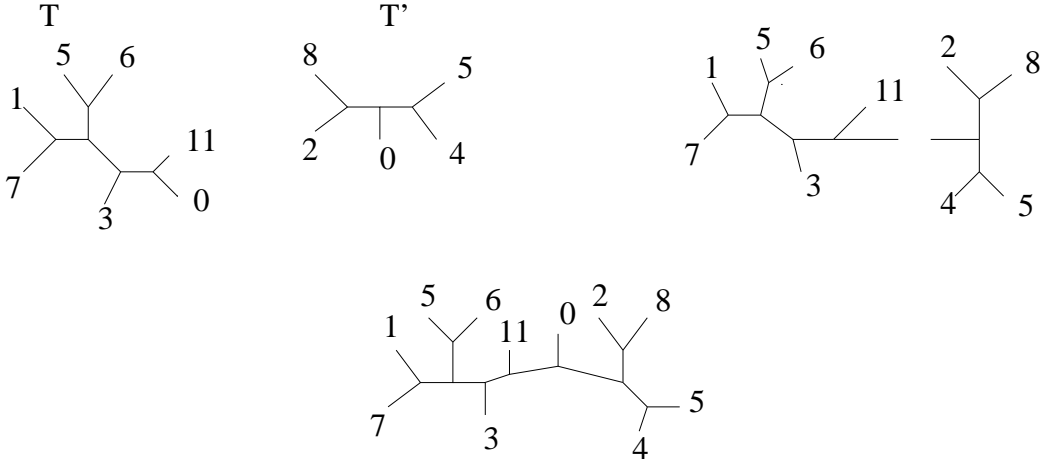

This category plays an important role in our situation, i.e. in the study of the geometry of moduli spaces and Grothendieck-Teichmüller theory, in two related ways:

- 1) For each $n \geq 4$, the full subcategory of objects (trees) which are n -tailed trees labeled with the integers $0, \dots, n - 1$ is naturally isomorphic to the *fundamental groupoid of the moduli space $M_{0,n}$ based at tangential base points at infinity*.
- 2) The profinite braided tree category, which is the category defined above except that instead the braid groups of morphisms are replaced by their profinite completions, is a free* tensor category whose automorphism group is \widehat{GT} . This was proved by Drinfel'd (in the pro-unipotent rather than the profinite situation, but it works the same way).

We explain these two points more completely in the following section, particularly the first one.

§II.3. ... and the fundamental groupoid of $M_{0,n}$

Let us explain point 1) above, i.e. how the n -tailed part of the braided tree category describes the fundamental groupoid of the genus zero moduli space.

- **Objects:** Identify a trivalent tree graph numbered from 0 to $n - 1$ with a point of maximal degeneration on $\overline{M}_{0,n}$, i.e. a genus zero Riemann surface with n marked points numbered 1 to n (renumber 0 to n) with $n - 3$ disjoint simple geodesic loops pinched to

* Here **free** means that there are no relations between morphisms other than those coming from Mac Lane's hexagons and pentagon.

length 0 (see §II.1).

Next, identify each *planar embedding* of the numbered trivalent tree with a tangential base point (see §II.1).

- **A-move:** Every point on $M_{0,n}(\mathbb{R})$ has a natural *cyclic order* since the marked points lie on \mathbb{R} . Since a tangential base point corresponds to a numbered planar tree, it has a natural cyclic order.

The region described in moduli space by a *fixed cyclic order* is clearly simply connected (all ways of sliding the points along the real axis without letting them cross are homotopic).

An A-move takes a planar tree T to another T' with the same cyclic order. Therefore, the tangential base points B_T and $B_{T'}$ associated to these trees both lie in the simply connected region associated to their common cyclic order. We interpret the A-move from T to T' as the unique (up to homotopy) path on $M_{0,n}$ from B_T to $B_{T'}$ lying in this region.

- **Crossing-braid:** We interpret a crossing braid as a path on the moduli space given by a $1/2$ Dehn twist, as follows.

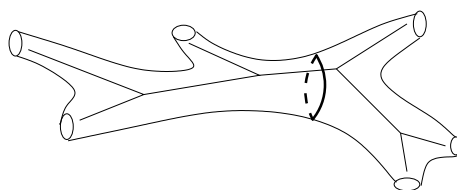

Another way to see this is as a movement of points on the sphere, parametrizing a path (up to homotopy) on the moduli space $M_{0,n}$:

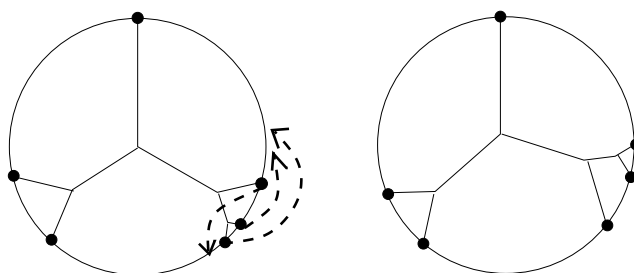

The pentagon and hexagon relations interpreted on the moduli space mean that certain loops formed by sequences of commutativity and A (associativity) paths are homotopic to the identity.

This is clear by the figure on page 23. Indeed, these sequences of paths form braids, thus elements of the fundamental group of $M_{0,n}$ (which are basically braid groups), and by inspection the braids in question are trivial braids. This shows how one can read off

the fundamental groupoid of $M_{0,n}$ based at maximal degeneration tangential base points from the free braided tree category.

The original definition of \widehat{GT}

Let us briefly explain how the group \widehat{GT} actually arose within this context.

Drinfel'd considered a braided tensor category similar to the one defined above (except that he worked in the k -pro-unipotent situation, with vector spaces defined over a field k). He asked the basic question: *what are all the possible ways in which one can modify the associativity and commutativity constraints while preserving all objects and diagrams?* The answer in the profinite situation is the same as the one he obtained in the k -pro-unipotent situation. The only possibilities are of the form

$$\begin{cases} c_{U,V} & \mapsto & c_{U,V} \cdot (c_{V,U}c_{U,V})^{(\lambda-1)/2} \\ a_{U,V,W} & \mapsto & a_{U,V,W} \cdot f(c_{V,U}c_{U,V}, c_{W,V}c_{V,W}) \end{cases}$$

for a pair $(\lambda, f) \in \mathbb{Z}^* \times \widehat{F}'_2$. But in order for a given pair (λ, f) to work, the new associativity and commutativity constraints must still satisfy the pentagon and hexagon relations, and this is exactly equivalent to requiring the pair (λ, f) to satisfy the defining relations (I), (II) and (III) of \widehat{GT} .

By considering the free braided tensor category as a geometric object connected to the fundamental groupoid of $M_{0,n}$, we will explain the geometric/arithmetic significance of this view of \widehat{GT} in §II.5, when we give the proof of the Lego Theorem. Before that, let us show how to generalize the construction of the braided tree category to higher genus.

§II.4. Higher genus: the Hatcher-Thurston curve complex

The goal of this section is to introduce a new combinatorial structure which is a generalization of the braided tree category to higher genus, and will play the same role as the braided tree category for the higher genus version of \widehat{GT} . We introduce two versions of this structure: the *Hatcher-Thurston curve complex* HT , which is fundamental for the proof of the Lego Theorem, and the refined *seamed Hatcher-Thurston curve complex* SHT , which bears the same relation to the fundamental groupoid of higher genus moduli space based at tangential base points at infinity that the braided tree category does in genus zero.

II.4.1. Basic notions on curve complexes

The two basic notions are simple closed loops on a topological surface, and maximal disjoint collections of such loops. A maximal collection cuts the surface into “pants” (spheres with three holes).

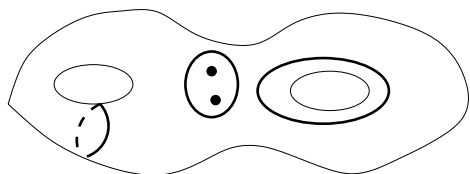

Simple closed loops on a topological surface

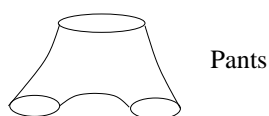

There are at most $3g-3+n$ disjoint simple closed loops on a surface of genus g with n marked points. They cut the surface into $2g-2+n$ pairs of pants

II.4.2. The 2-dimensional Hatcher-Thurston complex: definition

Vertices:

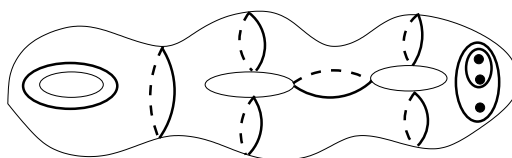

Pants decompositions (here of type (3,3))

Edges:

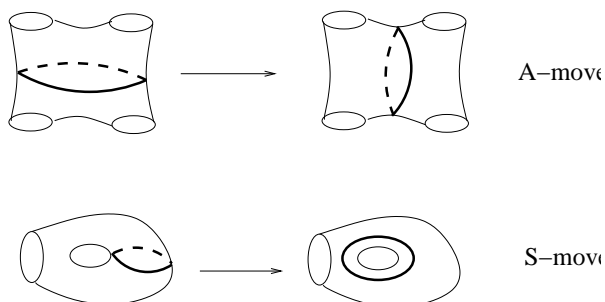

Faces: All 2-dimensional faces of the complex HT are given by the following sequences of moves.

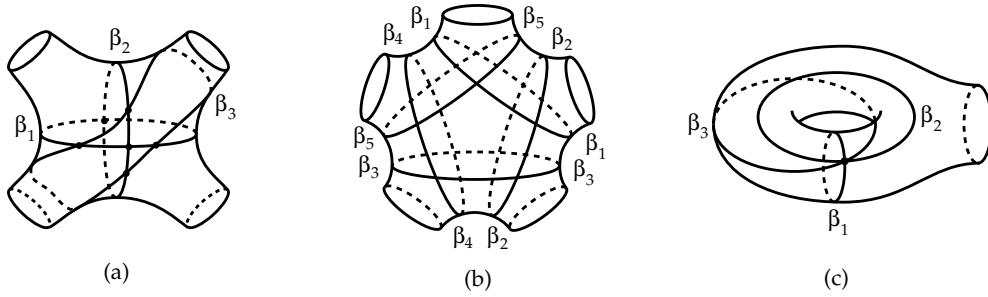

- (a) A sequence of 3 A-moves $\beta_1 \mapsto \beta_2 \mapsto \beta_3 \mapsto \beta_1$ supported on a sphere with four holes forms a triangular face of the complex (left-hand figure);
- (b) A sequence of 5 A-moves on the pants decomposition β_1, β_4 given by $\beta_1 \mapsto \beta_2, \beta_4 \mapsto \beta_5, \beta_2 \mapsto \beta_3, \beta_5 \mapsto \beta_1, \beta_3 \mapsto \beta_4$ forms a pentagonal face of the complex (middle figure);
- (c) A sequence of 3 S-moves $\beta_1 \mapsto \beta_2 \mapsto \beta_3$ forms a triangular face of the complex (right-hand figure);

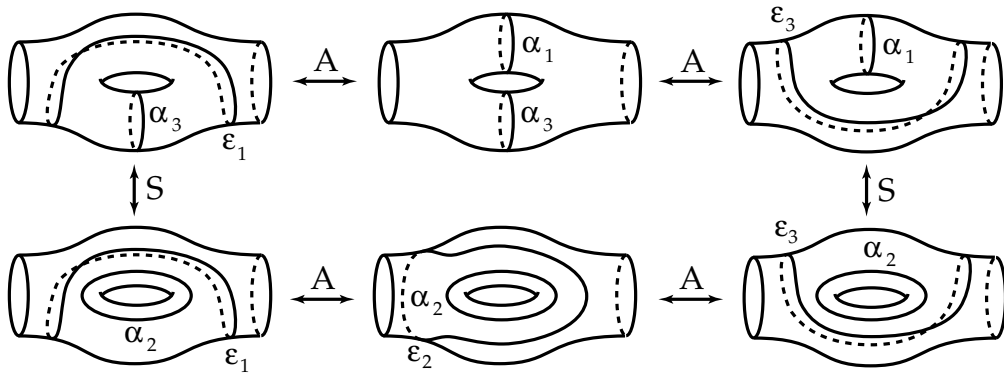

- (d) A sequence of 6 mixed A and S-moves as above forms a hexagonal face.

The main topological result we assume here is the following one (see [HLS] for a full proof using strictly topological methods).

Theorem. *The Hatcher-Thurston complex of curves HT is simply connected.*

We will explain the role of this result in Grothendieck-Teichmüller theory in §II.5. First let us explain the relation with the fundamental groupoid of $M_{g,n}$. For this, we give some remarks on the *seamed Hatcher-Thurston complex (SHT)*.

II.4.3. The seamed Hatcher-Thurston curve complex SHT

One can add structure to pants decompositions by adding *seams* as in the following

figure, and taking these seamed pants decomposition (called *quilts*) as vertices of *SHT*.

Vertices:

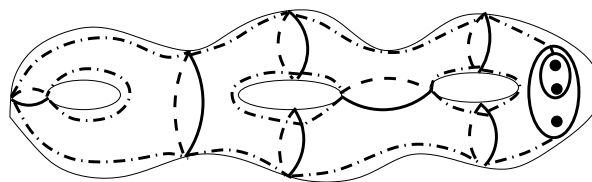

Seamed pants decompositions

The edges of *SHT* are a little complicated to describe. They are of three types. One type is a $1/2$ Dehn twist along a loop of the pants decomposition, which leaves the pants decomposition fixed but twists the seams (inverting two endpoints).

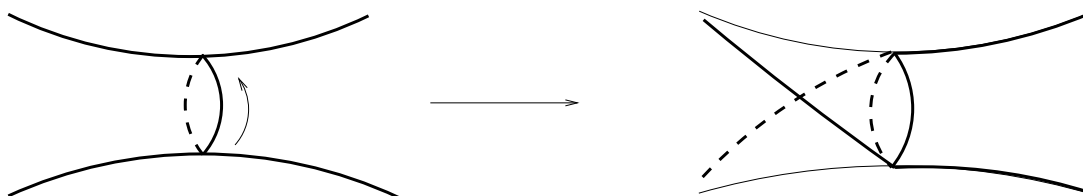

Then there are two kinds of moves corresponding to the A and S-moves of *HT*, except that in each one, after having moved one loop of the pants decomposition, one must make an adjusting operation on the seams in a specific way. For the case of an A-move taking a loop α to β , the adjusting operation concerns only the subsurface Σ_0 of type $(0, 4)$ on which the A-move takes place. The loop α cuts Σ_0 into two pants, and the quilt seams cut each pair of pants into two hexagonal patches. Having replaced α by β , one then acts on the seams of the quilt by the unique integral power N of the $1/2$ -twist $a_{1/2}$ such that the new seams intersect each of the four patches in a single segment. The adjustment operation for S moves is similar but a bit more complicated. See full details in [NS], §7, 530-532. This definition of A and S moves on quilts is designed so that the sequences of moves giving the faces (a),(b),(c),(d) of *HT* are exactly the same ones giving the faces of *SHT*. (Otherwise, we could have defined A and S moves by moving only the circles of the pants decomposition, but added the intervening twists to change the definition of the faces of *SHT*. This would give something more similar-looking to Mac Lane's hexagons.)

The curve complex *SHT* is simply connected, as an immediate corollary of the fact that *HT* is. Indeed, although the $1/2$ twists add new edges to *SHT*, they are of “infinite order” and yield no new loops. In fact, *SHT* is obtained from *HT* by replacing each vertex of *HT* (i.e. each pants decomposition) by the simply connected “star-shaped” region of

SHT consisting of all vertices of SHT with the same pants decomposition (but different quilts), connected by $1/2$ -twists. Thus, passing from HT to SHT does not change the simple-connectedness.

There is a natural action of the mapping class group $\Gamma_{g,n}$ on the complexes HT and SHT . Quotienting SHT by $\Gamma_{g,n}$ yields a complex which exactly describes the fundamental groupoid of the moduli space $M_{g,n}$ based at tangential base points at infinity. The seamed pants decompositions give all ways to choose tangential base points around a point of maximal degeneration (pants decomposition); i.e. they play exactly the role of the planar embeddings of graphs in genus zero. The edges (moves), including twists, can be interpreted naturally as paths on the higher genus moduli space exactly as we already saw in genus zero. We saw that an A-move corresponds to moving along a 1-dimensional stratum at the infinity of the moduli space in genus zero, i.e. a copy of $M_{0,4}$; an S-move in higher genus corresponds to similarly moving along a copy of $M_{1,1}$.

To get an idea of why this works, let us show that SHT in genus zero gives the same thing as the braided tree category.

To see this, consider the genus zero situation, and compare SHT with the braided tree complex. By forgetting the seams, an object gives a pants decomposition of a topological sphere with n numbered points, and this pants decomposition is (as we saw) dual to a numbered trivalent graph. Adding the seams (modulo action of $\Gamma_{0,n}$) corresponds exactly to determining an embedding of this tree in the plane, so the seamed pants decompositions correspond to tangential base points. An A-move on a seamed pants decomposition corresponds to an A-move on the tree, and a $1/2$ -twist corresponds to a crossing braid. So we have the same groupoid as before, which is isomorphic to the fundamental groupoid of $M_{0,n}$.

Something, however, is lost when passing from the braided tensor category to the seamed pants decomposition: namely, the former is much better understood, and in particular forms a tensor category. A tensor product has not been defined on the seamed pants decompositions; this would give an interesting generalization of braided tensor categories.

§II.5. The role of HT and SHT in Grothendieck-Teichmüller theory

The simple connectedness of the non-seamed complex HT is enough to prove the Lego Theorem stated in §I.9, with Λ replace by Λ_0 . In this section we state and prove the general version of this Lego Theorem, using SHT .

Recall that \widehat{GT} was defined by modifying the associativity and commutativity con-

straints of a braided tensor category via

$$\begin{cases} c_{U,V} \mapsto c_{U,V} \cdot (c_{V,U}c_{U,V})^{(\lambda-1)/2} \\ a_{U,V,W} \mapsto a \cdot f(c_{V,U}c_{U,V}, C_{W,V}c_{V,W}), \end{cases}$$

and that its defining relations (I), (II) and (III) came from requiring the new morphisms (i.e. λ and f) to respect the pentagon and hexagon diagrams of the braided tensor category.

We will first show that the four defining relations of the higher genus version Λ of \widehat{GT} come from modifying the morphisms of SHT in a manner analogous to the above for commutativity and associativity, and requiring that the faces still be respected. We now have not only the A-moves (associativity constraints) and 1/2 Dehn twists (commutativity constraints) of the genus zero situation, but also S-moves and two new diagrams to respect: the triangle of S-moves and the hexagon of mixed S and A-moves.

Explicitly, if α denotes a simple closed loop in a seamed pants decomposition P , and $a_{1/2}$ denotes the 1/2 twist along α and $A_{\alpha,\beta}$ is an A-move on P (resp. $S_{\alpha,\gamma}$ is an S-move on P), we have the formulae

$$\begin{cases} a_{1/2} \mapsto a_{1/2}^\lambda \\ A_{\alpha,\beta} \mapsto A_{\alpha,\beta} \cdot f(a,b)a^{N(\lambda-1)/2} \\ S_{\alpha,\beta} \mapsto S_{\alpha,\beta} \cdot (aba)^{\lambda-1}b^{N(\lambda-1)/2-8\rho_2}f(a^2,b^2)a^{8\rho_2} \end{cases} \quad (*)$$

for some $\lambda \in \mathbb{Z}^*$ and some $f \in \widehat{F}'_2$, where N is the integer occurring in the definition of A and S moves on quilts (see §II.4.3).

Now we see, in a precise generalization of Drinfel'd's result, that requiring the image A and S-moves to satisfy the four types of relations (faces) of SHT is equivalent to requiring f to satisfy the defining relations (I), (II), (III), (IV) of Λ . We will only show this completely for relation (IV), leaving the rest, and the simpler Λ_0 situation, as exercises for the reader.

Let us show it for the hexagonal face (d) of §II.4.2. Write this face as the sequence of moves

$$A_{\epsilon_1,\alpha_1}S_{\alpha_2,\alpha_3}A_{\epsilon_2,\epsilon_1}A_{\epsilon_3,\epsilon_2}S_{\alpha_1,\alpha_2}A_{\alpha_3,\epsilon_3} = 1$$

on any given quilt on $\Sigma_{1,2}$, for instance

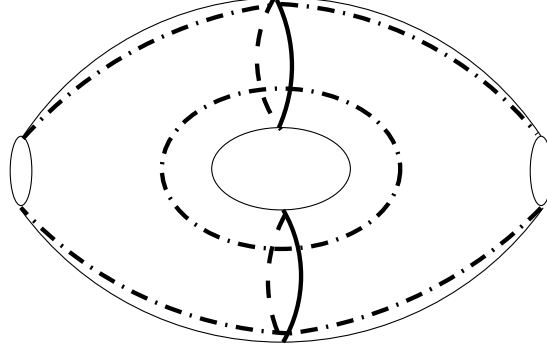

and apply (λ, f) to each move of the sequence by (*). We need to determine the adjustment integers N . The integers associated to the A-moves A_{α_3, ϵ_3} and A_{ϵ_1, α_1} are both zero since the seams of the quilt are simultaneously adjusted to all of these loops. The integer associated to the move $A_{\epsilon_3, \epsilon_2}$ is again 0, whereas that of $A_{\epsilon_2, \epsilon_1}$ can easily be determined to be 2. For the S-move S_{α_1, α_2} it is -2 , and for the S-move S_{α_2, α_3} it is 0. Thus we obtain

$$A_{\epsilon_1, \alpha_1} f(e_1, a_1) S_{\alpha_2, \alpha_3} (a_2 a_3 a_2)^{1-\lambda} a_3^{-8\rho_2} f(a_2^2, a_3^2) a_2^{8\rho_2} A_{\epsilon_2, \epsilon_1} f(e_2, e_1) e_2^{\lambda-1}.$$

$$A_{\epsilon_3, \epsilon_2} f(e_3, e_2) S_{\alpha_1, \alpha_2} (a_1 a_2 a_1)^{\lambda-1} a_2^{1-\lambda-8\rho_2} f(a_1^2, a_2^2) a_1^{8\rho_2} A_{\alpha_3, \epsilon_3} f(a_3, e_3) = 1.$$

Pushing all the moves to the left yields

$$f(e_1, a_1) (a_2 a_3 a_2)^{\lambda-1} a_3^{-8\rho_2} f(a_2^2, a_3^2) a_2^{8\rho_2} f(e_2, e_1) e_2^{\lambda-1}.$$

$$f(e_3, e_2) (a_1 a_2 a_1)^{\lambda-1} a_2^{1-\lambda-8\rho_2} f(a_1^2, a_2^2) a_1^{8\rho_2} f(a_3, e_3) = 1.$$

One can cancel $a_2^{8\rho_2}$ with $a_2^{-8\rho_2}$ as a_2 commutes with e_1, e_2 and e_3 , yielding exactly relation (IV) of §I.8.

Exercise 1. If $(\lambda, f) \in \Lambda_0$, then that (*) becomes just

$$\begin{cases} A_{\alpha, \beta} \mapsto A_{\alpha, \beta} \cdot f(a, b) \\ S_{\alpha, \beta} \mapsto S_{\alpha, \beta} \cdot f(a^2, b^2) \end{cases} \quad (*)_0$$

(there is no more adjustment of quilts). Show that if a pair $(\lambda = 1, f) \in \Lambda_0$ acts as in $(*)_0$, then it gives an automorphism of HT (i.e. respects the four types of faces) if and only if it belongs to Λ_0 .

Exercise 2. Show that (λ, f) acting on SHT as in (*) respects the faces (a), (b) and (c) of SHT if and only if it belongs to Λ .

What the result we showed together with exercise 2 proves is that a pair (λ, f) acting as in (*) gives an automorphism of the complex SHT if and only if it belongs to Λ .

(Exercise 1 shows that a pair $(1, f)$ acting as in $(*)_0$ gives an automorphism of HT if and only if it lies in Λ_0 .)

Let us now state the general form of the Lego Theorem, and show how this result, together with the simple connectedness of the curve complexes HT and SHT , is used to prove it.

General Lego Theorem. *Let S be a topological surface of type (g, n) and let P be a seamed pants decomposition on S . Let us introduce the notation*

$$\begin{cases} f_A(a, b) = f(a, b)a^{N(\lambda-1)/2} \\ f_S(a, b) = (aba)^{\lambda-1}b^{N(\lambda-1)/2-8\rho_2}f(a^2, b^2)a^{8\rho_2} \end{cases}$$

to simplify the notation of $(*)$. Then the homomorphism $\Lambda \rightarrow \text{Out}(\widehat{\Gamma}_{g,n})$ can be lifted to a homomorphism

$$\eta_P : \Lambda \rightarrow \text{Aut}_P(\widehat{\Gamma}_{g,n})$$

such that for all $F \in \Lambda$:

- (i) $\eta_P(F)(a) = a^\lambda$ if $\alpha \in P$;
- (ii) $\eta_P(F)(b) = f_A(a, b)^{-1}b^\lambda f_A(a, b)$ if $\alpha \rightarrow \beta$ is an A -move on P ;
- (iii) $\eta_P(F)(c) = f_S(a, c)^{-1}c^\lambda f_S(a, c)$ if $\alpha \rightarrow \gamma$ is an S -move on P .

Furthermore, if Q is another pants decomposition and $M_1 \dots M_r$ is any sequence of A and S moves taking P to Q , then setting $\epsilon_i = 1$ if M_i is an S -move and 2 if M_i is an A -move, and supposing that M_i takes the loop α_i to the loop β_i , the automorphisms $\eta_P(F)$ and $\eta_Q(F)$ are related by

$$\eta_Q(F) = \text{inn}\left(\prod_{i=1}^r f_{t_i}(a_i, b_i)\right) \circ \eta_P(F), \quad (**)$$

where t (the type) is given by A if M_i is an A -move and by S if M_i is an S -move. This expression $(**)$ is independent of the choice of sequence.

Fix a pants decomposition P on the topological surface Σ , let α be a loop of P , and let $F = (\lambda, f) \in \Lambda$.

The idea of the proof of this theorem is quite simply the following: to compute the action of $\eta_P(F)$ on $\widehat{\Gamma}_{g,n}$, we identify the set of elements of $\widehat{\Gamma}_{g,n}$ with the paths in SHT based at the seamed pants decomposition P . We know exactly how $\eta_P(F)$ acts on paths in SHT by $(*)$, so it suffices to express the elements of $\widehat{\Gamma}_{g,n}$ in the generators $a_{1/2}$, A and S of SHT .

We want to compute the action of $\eta_P(F)$ on three kinds of twists. A twist $a \in \widehat{\Gamma}_{g,n}$ is just the square of the $1/2$ twist $a_{1/2}$ in SHT . So if $\alpha \in P$, then we know that F maps the half-twist $a_{1/2}$ to $a_{1/2}^\lambda$ from (*), so we obtain $\eta_P(F)(a) = a^\lambda$. This proves (i).

If β is obtained from α by an A-move, this means that the twist b along β is the path based at P given by $A_{\beta,\alpha} b_{1/2}^2 A_{\alpha,\beta}$ in SHT . So

$$\begin{aligned}\eta_P(F)(b) &= \eta_P(F)(A_{\alpha,\beta})^{-1} \eta_P(F)(b_{1/2})^2 \eta_P(F)(A_{\alpha,\beta}) \\ &= f_A(a, b)^{-1} A_{\alpha,\beta}^{-1} (b_{1/2})^{2\lambda} A_{\alpha,\beta} f_A(a, b) \\ &= f_A(a, b)^{-1} b^\lambda f_A(a, b),\end{aligned}$$

since after the A move $A_{\alpha,\beta}$, we are located at the vertex P' containing β , so $\eta_P(F)$ acts on the half twist $b_{1/2}$ by (*), i.e. by sending it to $b_{1/2}^\lambda$.

Similarly, if γ is obtained from α by an S-move, this means that the twist c along γ is the path based at P given by $S_{\gamma,\alpha} c_{1/2}^2 S_{\alpha,\gamma}$ in SHT . So

$$\begin{aligned}\eta_P(F)(c) &= \eta_P(F)(S_{\alpha,\gamma})^{-1} \eta_P(F)(c_{1/2})^2 \eta_P(F)(S_{\alpha,\gamma}) \\ &= f_S(a, c)^{-1} S_{\alpha,\gamma}^{-1} (c_{1/2})^{2\lambda} S_{\alpha,\gamma} f_S(a, c) \\ &= f_S(a, c)^{-1} c^\lambda f_S(a, c).\end{aligned}$$

This proves the first part of the theorem, and yields a way to compute the action of $\eta_P(F)$ on any Dehn twist along a loop δ . It suffices to fit δ into a pants decomposition P' and to go from P to P' by a sequence $M_1 \dots M_n$ of A-moves and S-moves. If M_i takes the loop a_i to b_i , the action of $(\lambda, f) \in \Lambda$ on d is then given by

$$\left(\prod_{i=1}^n f_{t_i}(a_i, b_i) \right)^{-1} d^\lambda \left(\prod_{i=1}^n f_{t_i}(a_i, b_i) \right)$$

as in the theorem (where t_i is again the type A or S of M_i). It remains only to show that this action of Λ on a Dehn twist d is well-defined, i.e. that (***) is independent of the choice of the sequence of moves $M_1 \dots M_n$.

This works precisely thanks to the simple-connectedness of the curve complex SHT (or just HT if one only wants to prove the Lego theorem for Λ_0).

It is enough to consider the case where $M_1 \dots M_n$ is a sequence taking P to itself with each loop ending up in its original place, i.e. in the case where the sequence $M_1 \dots M_n$ is homotopic to the identity in the complex. We have to show that for every loop δ of P and every $F = (\lambda, f) \in \Lambda$, we have

$$\left(\prod_{i=1}^n f_{t_i}(a_i, b_i) \right)^{-1} d^\lambda \left(\prod_{i=1}^n f_{t_i}(a_i, b_i) \right) = d^\lambda.$$

But the definition of the complex by its four types of faces and the fact that it is simply connected shows that (up to inserting trivial pairs of moves AA^{-1} or SS^{-1}) the sequence $M_1 \cdots M_n$ can be broken up into r subsequences *each of which is one of the four types of basic subsequences homotopic to the identity*.

This means that the product

$$\prod_{i=1}^n f_{t_i}(a_i, b_i)$$

can be broken up into corresponding subproducts.

But each of those subproducts is trivial, because they are exactly the defining relations of Λ !

This concludes the proof of the Lego Theorem.

Part III: Linear Grothendieck-Teichmüller theory

§III.1. The Lie algebra associated to \widehat{GT}

Let $\mathbb{L} = \text{Lie}[x, y]$ be the free algebra on two generators. We will define the graded Lie algebra \mathbf{grt} , defined by Ihara and also called the stable derivation algebra. It is the set of elements $f \in \mathbb{L}$ satisfying

(I) $f(x, y) + f(y, x) = 0$

(II) $f(x, y) + f(z, x) + f(y, z) = 0$ where $x + y + z = 0$

(III) $\sum_{i \in \mathbb{Z}/5\mathbb{Z}} f(x_{i, i+1}, x_{i+1, i+2}) = 0$

where $x_{12}, x_{23}, x_{34}, x_{45}, x_{51}$ are the usual generators of the Lie algebra associated to $\Gamma_{0,5}$.

Why is this vector space a Lie algebra? One can interpret an element f of this vector space (or indeed, any element of \mathbb{L}) as a derivation of \mathbb{L} via $D_f(x) = 0, D_f(y) = [y, f]$. The Lie bracket on \mathbf{grt} is the restriction of the Lie bracket on derivations $[D_f, D_g] = D_f \circ D_g - D_g \circ D_f$, defined simply by composing derivations.

Exercise 1: Show that

$$[D_f, D_g] = D_h \quad \text{with} \quad h = [f, g] + D_f(g) - D_g(f).$$

We write $\{f, g\} = [f, g] + D_f(g) - D_g(f)$ for the Lie bracket directly on \mathbf{grt} . It is called the Poisson bracket. The fact that \mathbf{grt} is actually closed under the Poisson bracket is an important theorem due to Ihara (see [Y. Ihara, On the stable derivation algebra associated with some braid groups, *Isr. J. Math* **80** (1992) no. 2, 135-153.]).

§III.2. Multizeta values

The \mathbb{Q} -algebra of multizeta values. A *multizeta value* is a real number given by the formula

$$\zeta(k_1, \dots, k_r) = \sum_{n_1 > n_2 > \dots > n_r > 0} \frac{1}{n_1^{k_1} \dots n_r^{k_r}}.$$

This series converges when $k_1 \geq 2$. When $r = 1$, we have the standard Riemann zeta values

$$\zeta(k) = \sum_{n=1}^{\infty} \frac{1}{n^k}.$$

The sum $k_1 + \dots + k_r$ is called the *weight* of the multizeta value.

The key classical question concerning Riemann or multizeta values is whether they are transcendent. This is known for $\zeta(2) = \pi^2/6$ and therefore all $\zeta(2k)$ (see below), and

for $\zeta(3)$. It is extremely difficult. But one can also ask about algebraic relations between multizeta values. To do so, we need to know how to multiply them. There are two formulas. *The stuffle product.* The multizeta values form an algebra over \mathbb{Q} . This is because the product of two multizeta values is a linear combination of multizeta values. This is quite easy to see by multiplying the power series. Let us show how it works for a product $\zeta(a)\zeta(b, c)$. We have

$$\begin{aligned}\zeta(a)\zeta(b, c) &= \sum_{n=1}^{\infty} \frac{1}{n^a} \sum_{n_1 > n_2 > 0} \frac{1}{n_1^b n_2^c} \\ &= \sum_{n > n_1 > n_2} \frac{1}{n^a n_1^b n_2^c} + \sum_{n = n_1 > n_2 > 0} \frac{1}{n_1^{a+b} n_2^c} + \sum_{n_1 > n > n_2 > 0} \frac{1}{n_1^b n^a n_2^c} \\ &\quad + \sum_{n_1 > n = n_2 > 0} \frac{1}{n_1^b n_2^{a+c}} + \sum_{n_1 > n_2 > n > 0} \frac{1}{n_1^b n_2^c n^a} \\ &= \zeta(a, b, c) + \zeta(a + b, c) + \zeta(b, a, c) + \zeta(b, a + c) + \zeta(b, c, a).\end{aligned}$$

In general, the product $\zeta(k_1, \dots, k_r)\zeta(l_1, \dots, l_s)$ is given by the sum of ζ values for the tuples contained in the *stuffle product* of the two sequences $\underline{s} = (k_1, \dots, k_r)$ and $\underline{t} = (l_1, \dots, l_s)$. This stuffle product is defined recursively by $\text{st}(\underline{s}, \emptyset) = \text{st}(\emptyset, \underline{s}) = \underline{s}$ and

$$\text{st}(\underline{s} \cdot k, \underline{t} \cdot l) = \text{st}(\underline{s} \cdot k, \underline{t}) \cdot l \cup \text{st}(\underline{s}, \underline{t} \cdot l) \cdot k \cup \text{st}(\underline{s}, \underline{t}) \cdot (k + l),$$

where k and l are singletons and $\underline{s} \cdot k$ denotes the sequence (k_1, \dots, k_r, k) . For instance, taking $\underline{s} = \underline{t} = \emptyset$ and $k = a, l = b$, we find that

$$\text{st}(a, b) = \text{st}(a, \emptyset) \cdot b \cup \text{st}(\emptyset, b) \cdot a \cup \text{st}(\emptyset, \emptyset) \cdot (a + b) = \{ab, ba, a + b\}.$$

Exercise. Apply the formula to $\underline{s} = \emptyset, k = a, \underline{t} = (b)$ and $l = c$ to check that

$$\text{st}((a), (b, c)) = \{(a, b, c), (b, a, c), (b, c, a), (a + b, c), (b, a + c)\}$$

as above.

Iterated integrals and the shuffle product. To any r -tuple (k_1, \dots, k_r) with $k_1 \geq 2$, associate the word $w = x^{k_1-1}y x^{k_2-1}y \dots x^{k_r-1}y$ in non-commutative letters x and y . We have the following identity for multizeta values:

$$\zeta(k_1, \dots, k_r) = (-1)^r \int_0^1 \frac{dt_n}{t_n - \epsilon_n} \int_0^{t_n} \frac{dt_{n-1}}{t_{n-1} - \epsilon_{n-1}} \dots \int_0^{t_2} \frac{dt_1}{t_1 - \epsilon_1}$$

where ϵ_i is equal to 0 if the $(n - i)$ -th letter of w is an x and to 1 if the $(n - i)$ -th letter of w is a y .

Exercise. Prove by induction that

$$\sum_{n_1 > \dots > n_r > 0} \frac{z^{n_1}}{n_1^{k_1} \dots n_r^{k_r}} = (-1)^r \int_0^z \frac{dt_n}{t_n - \epsilon_n} \int_0^{t_n} \frac{dt_{n-1}}{t_{n-1} - \epsilon_{n-1}} \dots \int_0^{t_2} \frac{dt_1}{t_1 - \epsilon_1}.$$

Deduce the integral identity above by setting $z = 1$.

This identity gives another way of multiplying two multizeta values. One considers the integral as a multiple integral over the region

$$0 < t_1 < \dots < t_n < 1.$$

When multiplying such a domain with another one $0 < s_1 < \dots < s_m < 1$, one can cut the product domain into pieces according to the ordering of the $n+m$ -tuple $(t_1, \dots, t_n, s_1, \dots, s_m)$. The integral over the subdomains where some s_i is equal to some t_j is always zero since the dimension is too small, so we only need keep the pieces where all the s_i and t_i are different. Associating as before the word $w = x^{k_1-1}y \dots x^{k_r-1}y$ to the r -tuple (k_1, \dots, k_r) and $v = x^{l_1-1}y \dots x^{l_s-1}y$ to the s -tuple (l_1, \dots, l_s) , and writing $\zeta(w) = \zeta(k_1, \dots, k_r)$, we find that

$$\zeta(w)\zeta(v) = \sum_{u \in \text{sh}(w,v)} \zeta(u),$$

where the *shuffle product* $\text{sh}(w, v)$ is the set of words obtained by putting the letters of w and v together to form a single word which preserves the order of the letters of w and of those of v . Recursively, the shuffle product is defined by $\text{sh}(w, \emptyset) = \text{sh}(\emptyset, w) = w$ and

$$\text{sh}(w \cdot a, v \cdot b) = \text{sh}(w \cdot a, v) \cdot b \cup \text{sh}(w, v \cdot b) \cdot a.$$

Algebraic relations between multizeta values. It is conjectured that there are no linear relations between multizeta values of different weights. This conjecture is extremely strong; it would in particular imply the transcendence conjecture, as a minimal polynomial for some given multizeta value would translate, using the multiplication rules above, into a linear relation mixing different weights.

However, there is somewhat more hope of obtaining an understanding of the linear relations between multizeta values of the same weight. The multizeta values of given weight form a vector space over \mathbb{Q} . Dimensions and bases for these have been computed up to about weight 19. This leads to some very pretty conjectures.

Conjecture 1. (Zagier's dimension conjecture). Let $d_0 = 1$, $d_1 = 0$ and $d_2 = 1$, and define a sequence recursively by $d_n = d_{n-2} + d_{n-3}$. Then for $n \geq 2$, d_n is the dimension of the weight n part of the multizeta algebra.

Conjecture 2. All algebraic relations between multizeta values in a given weight can be deduced from the shuffle and stuffle families (called the double shuffle system) of algebraic relations given above.

§III.3. The Grothendieck-Teichmüller (and other) algebraic relations

The shuffle regularization. We saw above that if $k_1 \geq 2$, we can associate the word $w = x^{k_1-1}y \cdots x^{k_r-1}y$ to the r -tuple (k_1, \dots, k_r) and write $\zeta(w)$ instead of $\zeta(k_1, \dots, k_r)$. However, only words starting in x and ending in y arise this way. Now we give a formula generalizing this, defining a real value $\zeta(w)$ for all words w in x and y such that

$$\zeta(w)\zeta(v) = \sum_{u \in \text{sh}(w,v)} \zeta(u)$$

for any words w, v , not just convergent words. The formula is the final product of substantial work due to Drinfel'd, Le and Murakami and Furusho. We give it here without proof.

Write $w = y^bvx^a$ where $v = 1$ or v is a word starting in x and ending in y . Note that shuffle is an associative binary operation, so for three words, we can write $\text{sh}(u, v, w)$. For any set of words W , let $\pi(W)$ denote the ‘‘projection’’ onto those words starting in x and ending in y , i.e. $\pi(W)$ is the subset of W consisting of such words. Then we set $\zeta(1) = 1$ and for all non-trivial words,

$$\zeta(w) = \sum_{r=0}^a \sum_{s=0}^b \sum_{u \in E_{r,s}} \zeta(u)$$

where for each r, s in the sum, we set

$$E_{r,s} = \pi(\text{sh}(y^s, y^{b-s}vx^{a-r}, x^r)).$$

Algebraic relations between multizeta values. Recall that it is conjectured that all algebraic relations between multizeta values taking place in a given weight come from the double shuffle relations.

Many algebraic relations between multizeta values are known, and only some of them are known to be deducible from the double shuffle system. So if we can deduce even some of them, that would be evidence in favor of conjecture 2. This is the subject of our research project.

Here are a few relations to start investigating with.

$$(1) \quad \zeta(3) = \zeta(2, 1) \quad \text{and} \quad \zeta(4) = \zeta(3, 1) + \zeta(2, 2).$$

These are special cases of the relation

$$(2) \quad \sum_{i_1 + \dots + i_k = n, i_1 > 1} \zeta(i_1, \dots, i_k) = \zeta(n)$$

This relation was proved by Euler for $k = 2$, in 1996 for $k = 3$ and quite recently for all k by Granville and Zagier.

$$(3) \quad \zeta(4) = \zeta(2, 1, 1).$$

Anyone want to conjecture (and/or prove) that $\zeta(n) = \zeta(2, 1, \dots, 1)$?

$$(4) \quad \zeta(3, 1, \dots, 3, 1) = \frac{1}{2n+1} \zeta(2, 2, \dots, 2) \text{ in weight } 4n \text{ (Zagier)}.$$

A nice reference containing many more relations and references can be found at:
<http://www.usna.edu/Users/math/meh/mult.html>

Linearization. Before going on to our main goal, explaining an important family of “Grothendieck-Teichmüller” relations, let us show how we can simplify our problem by working, not in the algebra of multizeta-values but in the vector space NZ of *new zeta values* obtained by quotienting this algebra modulo products. For convenience, we also quotient it modulo \mathbb{Q} and $\zeta(2)$.

The double shuffle system then becomes a family of linear relations (by an abuse of notation, we continue to write $\zeta(w)$ for the image modulo products):

$$\sum_{u \in \text{sh}(w,v)} \zeta(u) = 0 \quad \text{for all } w, v$$

$$\sum_{r \in \text{st}(\underline{s}, \underline{t})} \zeta(r) = 0 \quad \text{for all } \underline{s}, \underline{t} \text{ not both sequences of 1's.}$$

The restriction on the 1’s is technical; it arises because the formula for $\zeta(w)$ above is made to ensure that the generalized ζ satisfies the shuffle relations but not the stuffle relations. The latter fail when both sequences consist in 1’s. In fact, one can “correct” the definition of ζ to one which respects all stuffle relations, but then some shuffles fail. It is known that there is no possible way to define a generalized ζ simultaneously satisfying all of both.

Now we can introduce our main new family of algebraic (now linear) relations on ζ -values.

The Drinfel'd associator. The Drinfel'd associator is the power series in the non-commutative variables x and y with real coefficients defined by

$$\Phi_{KZ} = \Phi_{KZ}(x, y) = 1 + \sum_w (-1)^{d(w)} \zeta(w)w,$$

where $d(w)$ denotes the number of y 's appearing in the word w . The *new* Drinfel'd associator Φ is the image of Φ_{KZ} in NZ . The first terms in the expansion of Φ_{KZ} and Φ are given by

$$\begin{aligned} \Phi_{KZ}(x, y) &= 1 - \zeta(2)xy + \zeta(2)yx - \zeta(3)x^2y + 2\zeta(3)xyx - \zeta(3)yx^2 \\ &\quad + \zeta(2, 1)xy^2 - 2\zeta(2, 1)yxy + \zeta(2, 1)y^2x + \dots \end{aligned}$$

$$\Phi(x, y) = -\zeta(3)x^2y + 2\zeta(3)xyx - \zeta(3)yx^2 + \zeta(2, 1)xy^2 - 2\zeta(2, 1)yxy + \zeta(2, 1)y^2x + \dots$$

The "Grothendieck-Teichmüller" relations. Drinfel'd's key theorem concerning the new associator states that it satisfies three relations.

Theorem. The new associator Φ satisfies the three defining relations of **grt**:

- (I) $\Phi(x, y) + \Phi(y, x) = 0$,
- (II) $\Phi(x, y) + \Phi(z, x) + \Phi(y, z) = 0$ where $x + y + z = 1$,
- (III) $\Phi(x_{12}, x_{23})\Phi(x_{34}, x_{45})\Phi(x_{51}, x_{12})\Phi(x_{23}, x_{34})\Phi(x_{45}, x_{51}) = 0$ where the x_{ij} are the standard generators of the 5-strand braid Lie algebra.

Clearly these relations on Φ yield an infinity of relations on the $\zeta(w)$. For example, using the first terms of $\Phi(x, y)$ given above, relation (I) says that

$$\begin{aligned} 0 &= \Phi(x, y) + \Phi(y, x) = \\ &-\zeta(3)x^2y + 2\zeta(3)xyx - \zeta(3)yx^2 + \zeta(2, 1)xy^2 - 2\zeta(2, 1)yxy + \zeta(2, 1)y^2x + \dots \\ &-\zeta(3)y^2x + 2\zeta(3)yxy - \zeta(3)xy^2 + \zeta(2, 1)yx^2 - 2\zeta(2, 1)xyx + \zeta(2, 1)x^2y + \dots \end{aligned}$$

Comparing coefficients of the same words immediately shows that we must have

$$\zeta(3) = \zeta(2, 1).$$

Note that this is the first of the classical relations mentioned earlier. The conjecture says that we should be able to deduce this and all other relations arising from (I), (II) and (III) (or anywhere else) from double shuffle.

Research project. (1) Try to deduce some of the above classical relations from double shuffle.

(2) Compute new (linearized) relations on ζ -values using relations (I) and maybe even (II).

(3) Deduce these also from double shuffle.

A useful reference for this material can be found on ArXiv:

H. Furusho, The multiple zeta value algebra and the stable derivation algebra.